

REVISION HISTORY			
REV	DESCRIPTION	DATE	CHECKED BY
A0	DRAWING RELEASED	2023-08-29	Howard S.

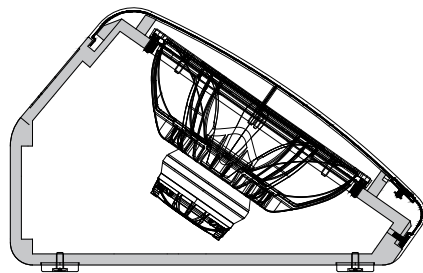

SECTION

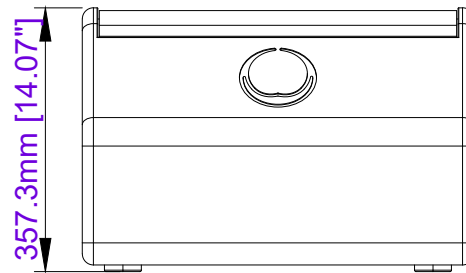

BACK

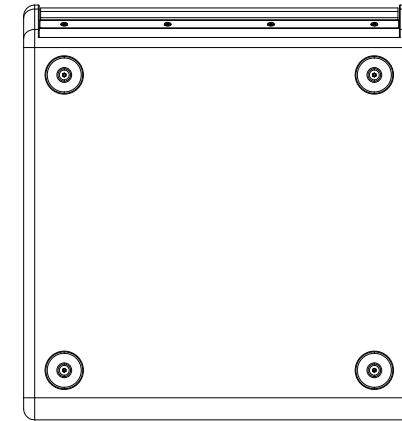

BOTTOM

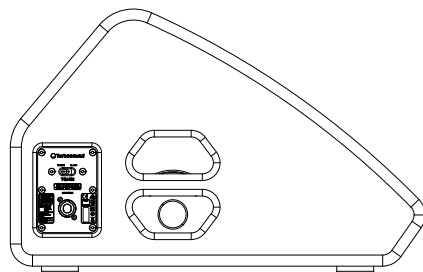

LEFT

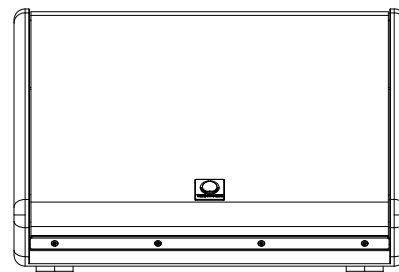

FRONT

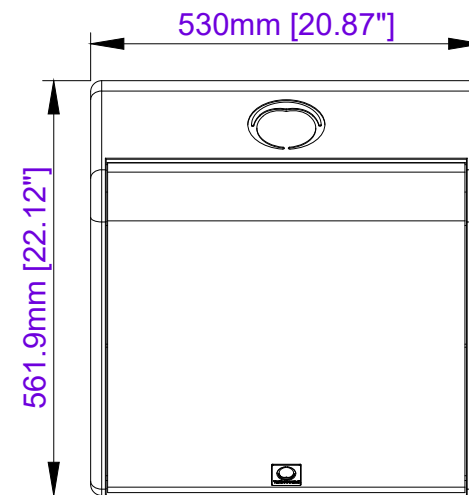

TOP

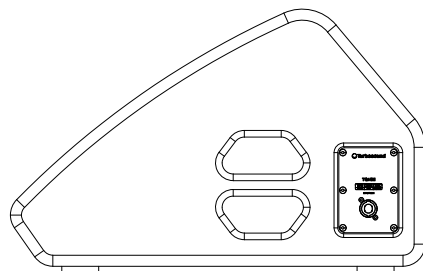

RIGHT

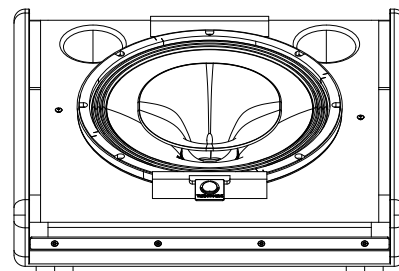

FRONT  
(Grille removed for clarity)

**Turbosound**

INTERNAL CODE: 0313-AIR  
 MATERIAL ID: -  
 ALL DIMENSIONS IN X.XXmm[X.XXXin]  
 DO NOT SCALE DRAWING

NAME: TURBOSOUND TQ14M

SCALE: NTS SHEET 1 OF 1

ALL INFORMATION INCLUDING DRAWINGS AND DIAGRAMS CONTAINED IN THIS DOCUMENT IS THE PROPERTY OF MUSIC TRUST. ADDRESSES WHOM THE INFORMATION IS CONFIDED TO SHALL MAINTAIN THE INFORMATION IN CONFIDENCE AND SHALL NOT RELEASE IT TO ANY UNAUTHORIZED THIRD PARTY. SUBJECT UNDER ATTORNEY-CLIENT PRIVILEGE OR UNDER APPROPRIATE CONFIDENTIALITY AGREEMENTS. ANY UNAUTHORIZED DISCLOSURE, USE, APPLICATION OR ANY OTHER DEALINGS IN THE INFORMATION SHALL RESULT IN CIVIL AND/OR CRIMINAL LIABILITY AND PENALTIES.