

REVISION HISTORY			
REV	DESCRIPTION	DATE	CHECKED BY
A0	DRAWING RELEASED	2023-08-29	Howard S.

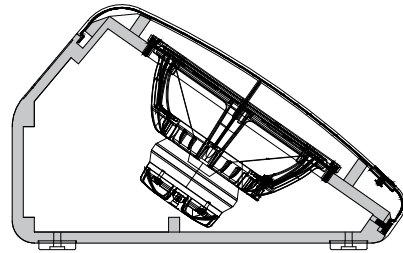

SECTION

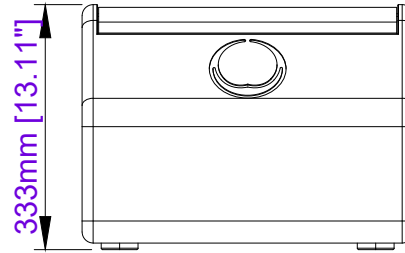

BACK

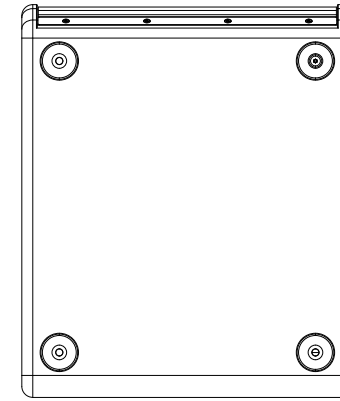

BOTTOM

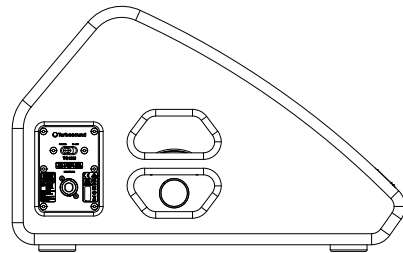

LEFT

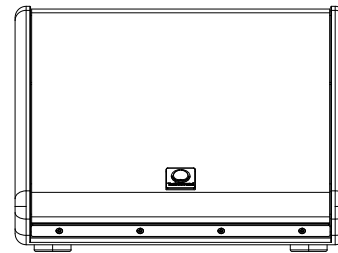

FRONT

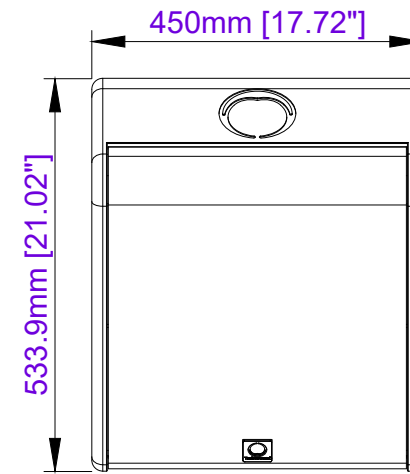

TOP

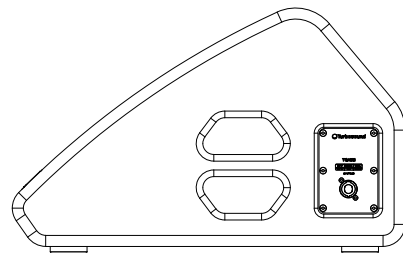

RIGHT

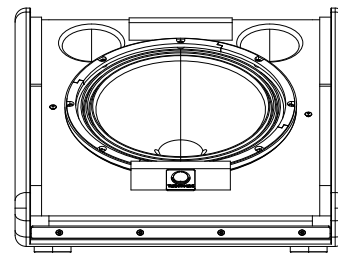

FRONT
(Grille removed for clarity)

		<small>ALL INFORMATION (INCLUDING DRAWINGS AND DIAGRAMS) CONTAINED IN THIS DOCUMENT IS THE PROPERTY OF MUSIC TRIBE. ADDRESSEES WITHIN THE INDUSTRY TO WHOM THIS INFORMATION IS CONFIDENTIAL SHALL MAINTAIN THE INFORMATION IN CONFIDENCE AND SHALL NOT RELEASE IT TO ANY UNAUTHORIZED THIRD PARTY (S) WITHOUT THE WRITTEN PERMISSION OF MUSIC TRIBE. UNDER NO CIRCUMSTANCES SHALL THIS INFORMATION BE USED FOR ANY OTHER PURPOSES. ANY UNAUTHORIZED DISCLOSURE, USE, REPRODUCTION OR ANY OTHER DEALINGS IN THE INFORMATION SHALL RESULT IN CIVIL AND/OR CRIMINAL LIABILITY AND PENALTIES.</small>	
INTERNAL CODE:	0313-AIQ	NAME:	TURBOSOUND TQ12M
MATERIAL ID:	-		
<small>ALL DIMENSIONS IN X.XXmm(X.XXXin) DO NOT SCALE DRAWING</small>			SCALE: NTS SHEET 1 OF 1